



GENERATOR TYPE ECO 32-1L/4

Document : **DS008A/1**

issue 007 date 24/07/2012

Electrical Characteristics										
Frequency	Hz	50				60				
Voltage (series star)	V	380	400	415	440	415	440	460	480	
Rated power class H	kVA	50	50	50	40	58	60	60	60	
	kW	40	40	40	32,0	46,4	48	48	48	
Rated power class F	kVA	48	48	48	38	56	58	58	58	
	kW	38,4	38,4	38,4	30,4	44,8	46,4	46,4	46,4	
Regulation with	DSR	±1 % with any power factor and speed variations between -5% +30%								
Insulation class		H								
Execution		Brushless								
Stator winding		12 ends								
Rotor		with damping cage								
Efficiencies class H	4/4	%	89	89,1	88,8	88,6	91,1	91,6	91,7	91,8
(see graph. for details)	3/4	%	89,2	89,5	89,4	89,1	91,5	91,7	91,9	92,1
	2/4	%	87,5	87,6	87,6	87,4	88,8	88,9	89	89,1
	1/4	%	85,5	85,3	85,1	84,6	85,4	85	85,5	85,4
Reactances (f. l.cl. F)										
	Xd	%	271,5	245	227,6	162,0	316,8	291,6	266,8	245
	Xd'	%	14,96	13,5	12,54	8,93	17,46	16,07	14,70	13,5
	Xd''	%	8,20	7,4	6,87	4,89	9,57	8,81	8,06	7,4
	Xq	%	113,0	102	94,8	67,4	131,9	121,4	111,1	102
	Xq'	%	113,0	102	94,8	67,4	131,9	121,4	111,1	102
	Xq''	%	34,9	31,5	29,3	20,8	40,7	37,5	34,3	31,5
	X ₂	%	23,27	21	19,51	13,88	27,16	24,99	22,87	21
	x ₀	%	3,21	2,9	2,69	1,92	3,75	3,45	3,16	2,9
Short Circuit Ratio	Kcc		0,62	0,71	0,73	1,30	0,40	0,48	0,62	0,71
Time Constants	Td'	sec.	0,059							
	Td''	sec.	0,013							
	Tdo'	sec.	1,40							
	Tα	sec.	0,035							
Short Circuit Current Capacity		%	>300				>350			
Excitation at no load	Amp.		0,6	0,7	0,8	1,2	0,3	0,4	0,5	0,6
Excitation at full load	Amp.		2,2	2,4	2,3	2,7	2,1	1,9	2,1	2,3
Overload (long-term)	%	1 hour in a 6 hours period 110% rated load								
Overload per 20 sec.	%	300								
Stator Winding Resistance (20°C)	Ω	0,061								
Rotor Winding Resistance (20°C)	Ω	2,473								
Exciter Resistance (20 °C)	Ω	Rotor : 0,442				Stator : 11,35				
Heat dissipation at f.l.cl.H	W	4944	4893	5045	4117	4533	4402	4345	4288	
Telephone Interference		THF < 2%				TIF < 45				
Radio interference		EN61000-6-3, EN61000-6-1. For others standards apply to factory								
Waveform Distors.(THD) at f. load	LL/LN %	3,8 / 3,6								
Waveform Distors.(THD) at no load	LL/LN %	3,3 / 3,2								
Mechanical characteristics										
Protection		IP 21 (other protection on request)								
DE bearing		6312-2RS								
NDE bearing		6309-2RS								
Weight of wound stator assembly	kg	78								
Weight of wound rotor assembly	kg	53								
Weight of complete generator	kg	248								
Maximun overspeed	rpm	2250								
Unbalanced magnetic pull at f.l.cl.F	kN/mm	4,1								
Cooling air requirement	m ³ /min	11,8				14,5				
Inertia Constant (H)	sec.	0,105				0,125				
Noise level at 1m/7m	dB(A)	75 / 60				79 / 64				

All technical data are to be considered as a reference and they can be modified without any notice.

This document is a propriety of Mecc Alte S.p.a..All rights reserved.



GENERATOR TYPE ECO 32-1L/4

Document : DS008A/2

issue 007 date : 24/07/2012

50 Hz

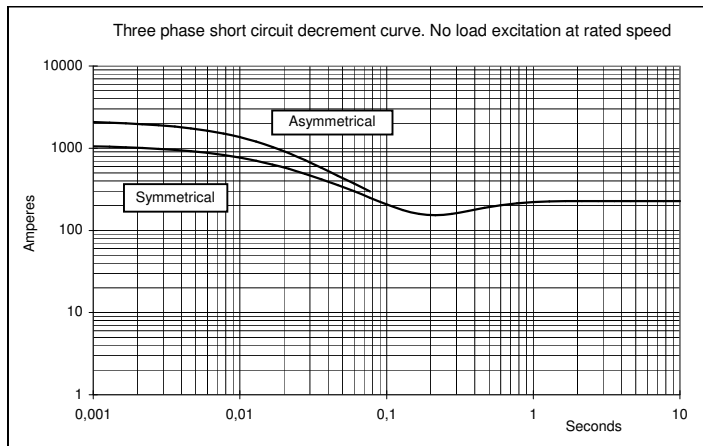
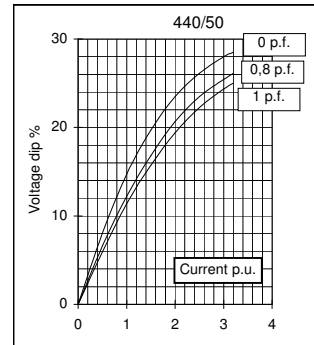
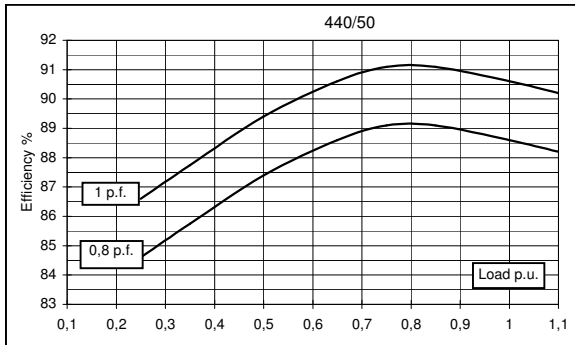
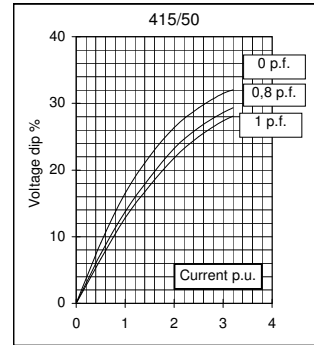
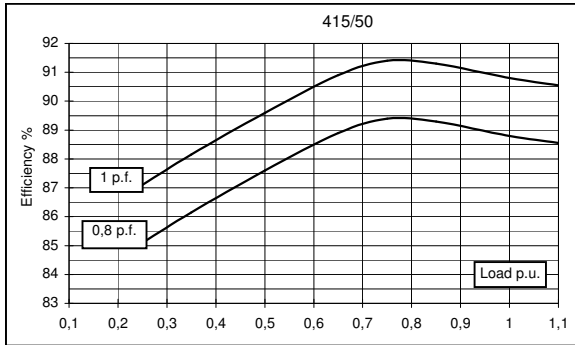
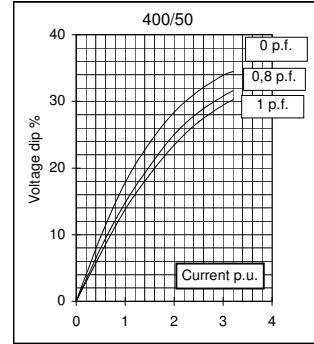
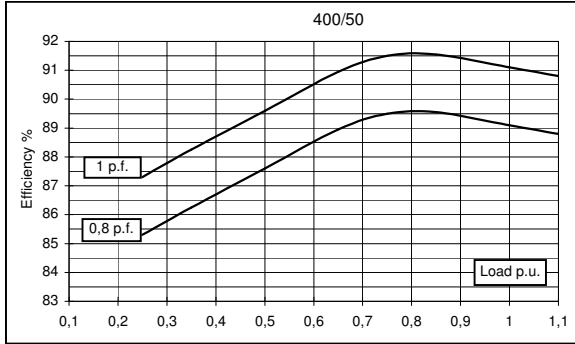
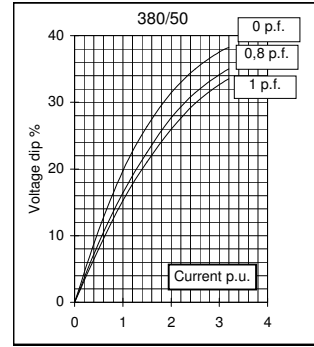
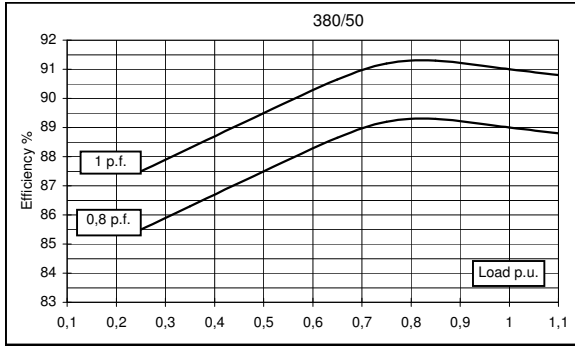

60 Hz

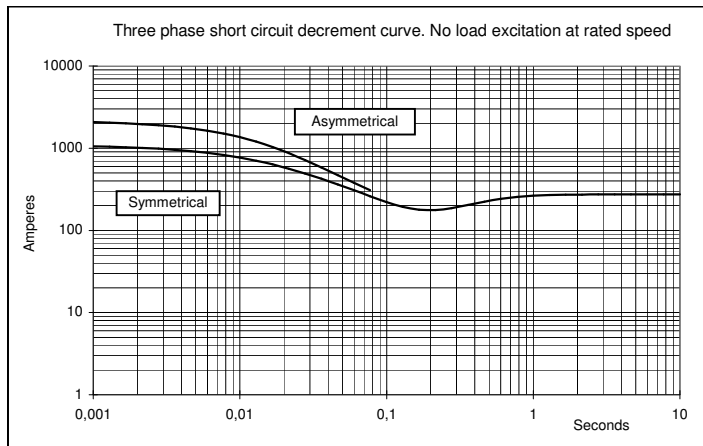
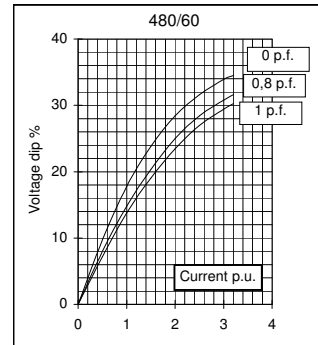
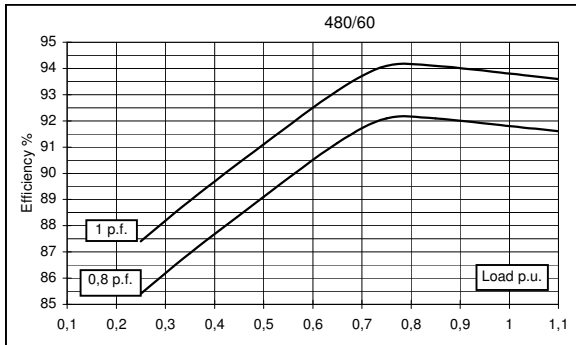
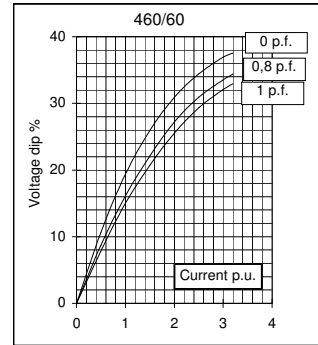
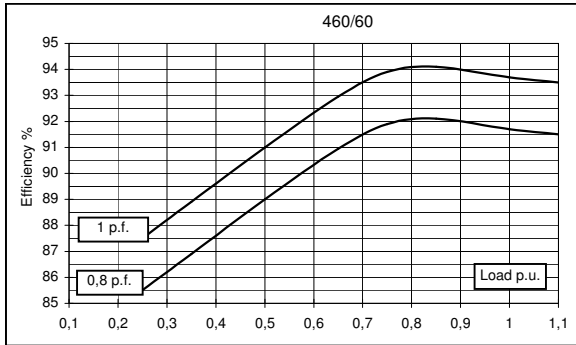
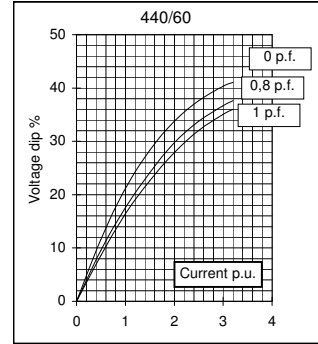
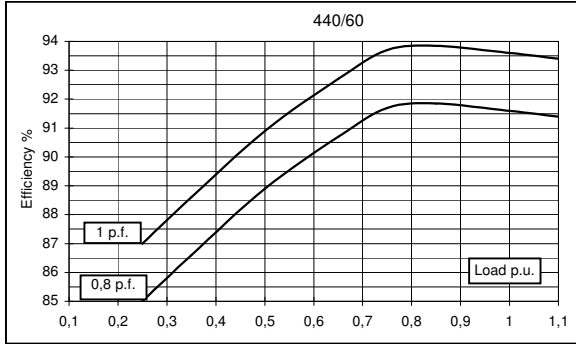
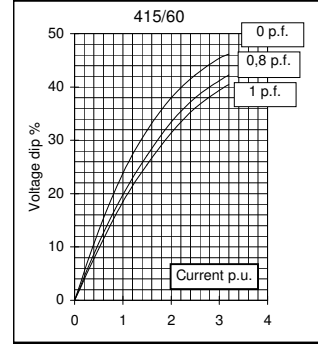
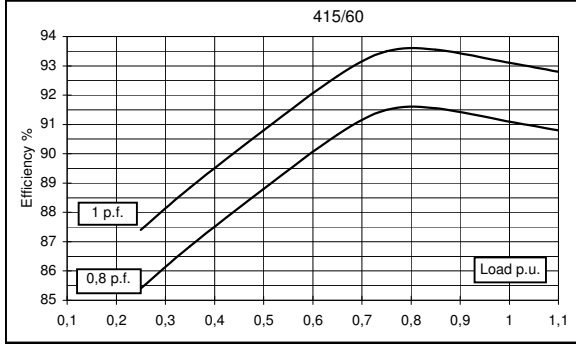

SINGLE BEARING MOMENTS OF INERTIA

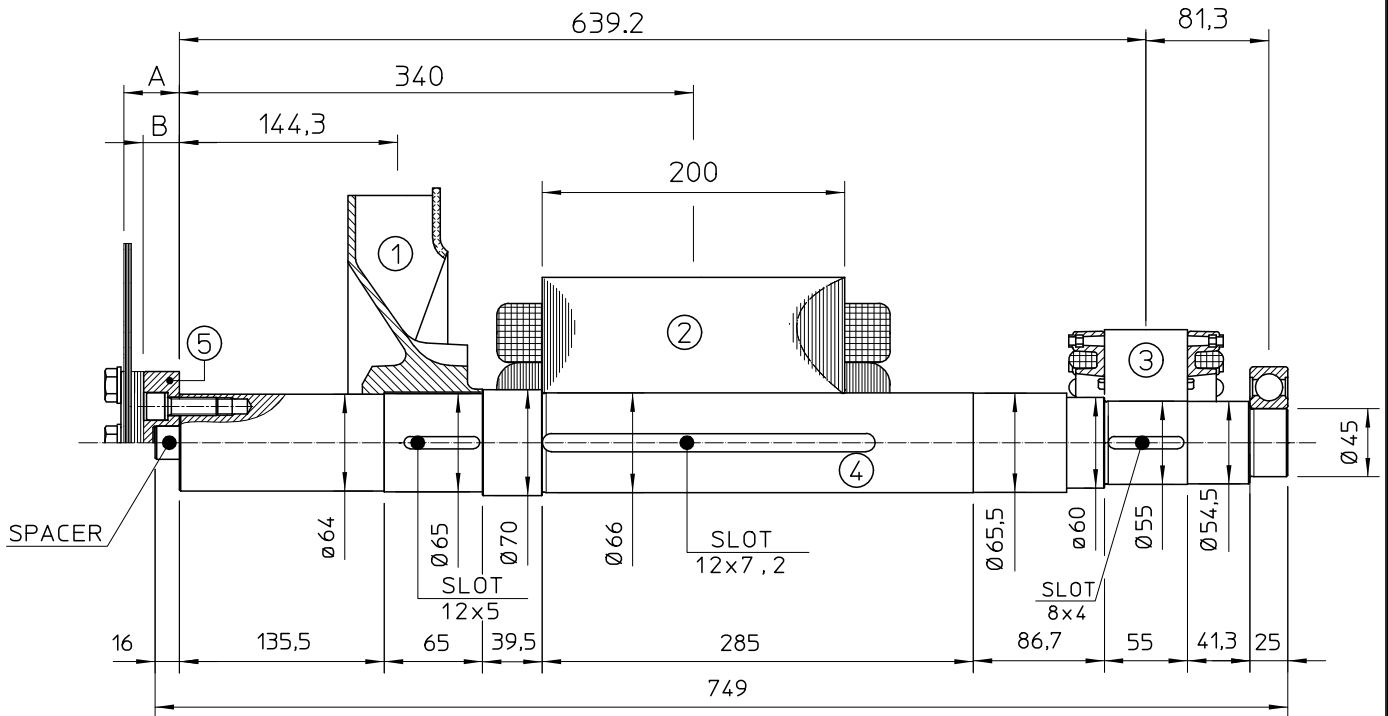

POS.	COMPONENT	WEIGHT (kg)	J (kgm ²)
1	FAN	2.3	0.0224
2	MAIN ROTOR	53	0.3763
3	EX. ROTOR	7	0.016
4	SHAFT	17.6	0.0090
TOTAL		79.9	0.4237

SAE N°	5		SHAFTS COUPLING FLEX PLATE	
	A	B	WEIGHT kg	J kgm ²
6.5	5	2.5	1.74	0.0084
7.5	5	2.5	2.1	0.013
8	36.6	28.1	3.9	0.02
10	28.6	21.6	4.47	0.038
11.5	15	11.5	4.51	0.059

SINGLE BEARING DIMENSIONS

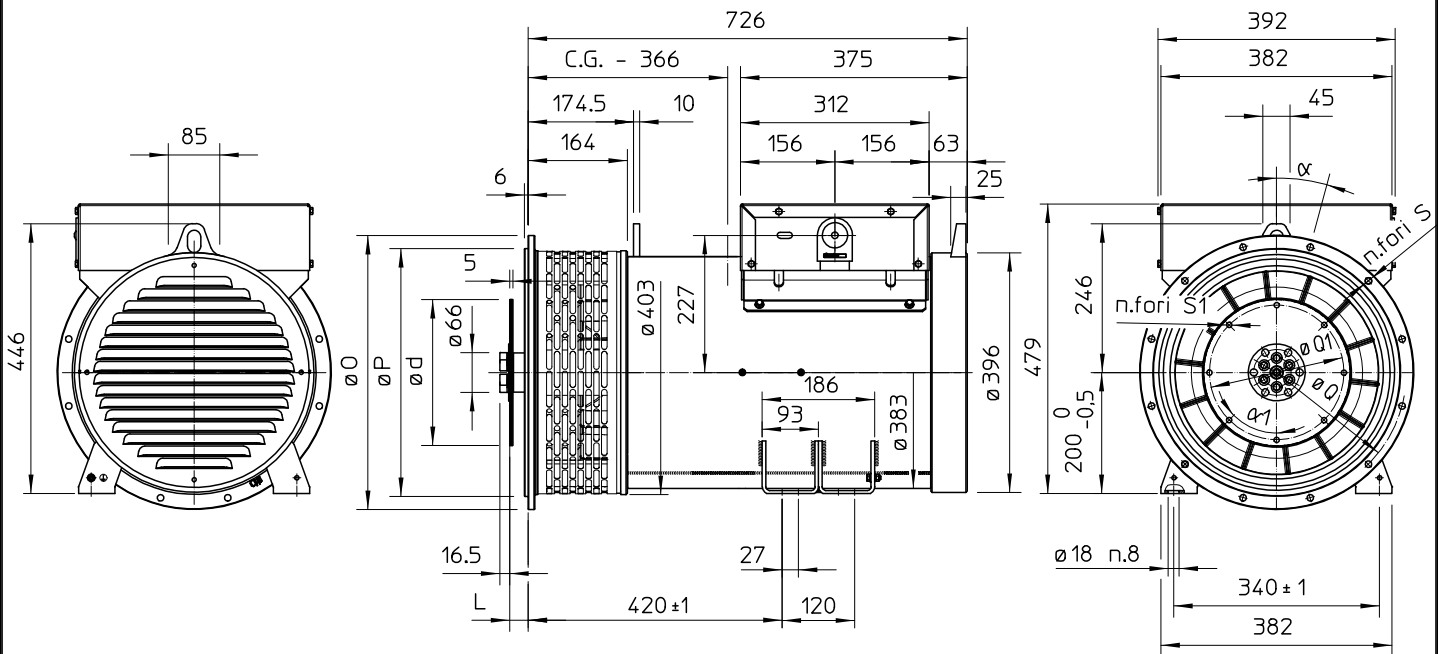

SAE N.	FLANGIA / FLANGE BRIDE / FLANSCH					
	O	P	Q	S	N. FORI HOLES N°	α
5	356	314.3	333.4	11	8	45
4	403	362	381	11	12	30
3	451	409.6	428.6	11	12	30
2	490	447.7	466.7	11	12	30
1	552	511.2	530.2	11	12	30

SAE N.	GIUNTI A DISCHI / DISC COUPLING DISCQUE DE MONOPALIER / SCHEIBENKUPPLUNG						
	d	L	Q1	S1	N. FORI HOLES N°	α1	
6 1/2	215.9	30.2	200	9	6	60	
7 1/2	241.3	30.2	222.25	9	8	45	
8	263.52	62	244.47	11	6	60	
10	314.32	53.8	295.27	11	8	45	
11 1/2	352.42	39.6	333.37	11	8	45	

C.G.= GRAVITY CENTER