

<b>Electrical Characteristics</b>										
Frequency	Hz	50				60				
Voltage (parallel star)	V	380	400	415	440	415	440	460	480	
Rated power class H	kVA	450	450	450	420	480	510	540	540	
	kW	360	360	360	336	384	408	432	432	
Rated power class F	kVA	410	410	410	385	435	460	490	490	
	kW	328	328	328	308	348	368	392	392	
Regulation with	DER1	±1% with any power factor and speed variations between -5% +30%								
Insulation class		H								
Execution		Brushless								
Stator winding		12 ends								
Rotor		with damping cage								
Efficiencies class H	4/4	%	93,4	93,7	93,4	93,2	94	94,5	94,6	94,7
(see graph. for details)	3/4	%	93,7	94	93,9	93,6	94,9	95,1	95,2	95,5
	2/4	%	93,1	93,2	93,2	93	93,9	94	94,1	94,2
	1/4	%	89,2	89	88,8	88,7	90	90,1	90,1	90
Reactances (f. l.cl. F)	Xd	%	382,9	345,6	321,1	266,6	411,0	388,4	376,3	345,6
	Xd'	%	30,1	27,2	25,3	21,0	32,3	30,6	29,6	27,2
	Xd''	%	18,7	16,9	15,7	13,0	20,1	19,0	18,4	16,9
	Xq	%	159,0	143,5	133,3	110,7	170,6	161,3	156,2	143,5
	Xq'	%	159,0	143,5	133,3	110,7	170,6	161,3	156,2	143,5
	Xq''	%	28,8	26	24,2	20,1	30,9	29,2	28,3	26
	X <sub>2</sub>	%	23,7	21,4	19,9	16,5	25,4	24,1	23,3	21,4
	X <sub>0</sub>	%	3,5	3,2	3,0	2,5	3,8	3,6	3,5	3,2
Short Circuit Ratio	Kcc		0,32	0,43	0,62	1,10	0,23	0,26	0,32	0,43
Time Constants	Td'	sec.	0,118							
	Td''	sec.	0,017							
	Tdo'	sec.	2,64							
	Tα	sec.	0,02							
Short Circuit Current Capacity		%	>300				>350			
Excitation at no load	Amp.		0,4	0,6	0,8	1	0,3	0,4	0,5	0,6
Excitation at full load	Amp.		3,3	3,4	3,7	3,9	2,8	2,9	3	3,2
Overload (long-term)		%	1 hour in a 6 hours period 110% rated load							
Overload per 20 sec.		%	300							
Stator Winding Resistance (20 °C)	Ω		0,013							
Rotor Winding Resistance (20 °C)	Ω		4,881							
Exciter Resistance (20 °C)	Ω		Rotor : 0,317				Stator : 8,85			
Heat dissipation at f.l.cl.H	W		25439	24205	25439	24515	24511	23746	24660	24177
Telephone Interference			THF < 2%				TIF < 40			
Radio interference			EN61000-6-3, EN61000-6-1. For others standards apply to factory							
Waveform Distors.(THD) at f. load	LL/LN %		2,5 / 2,6							
Waveform Distors.(THD) at no load	LL/LN %		2,7 / 2,8							
<b>Mechanical characteristics</b>										
Protection			IP 21 (other protection on request)							
DE bearing			6322							
NDE bearing			6318.2RS							
Weight of wound stator assembly	kg		382							
Weight of wound rotor assembly	kg		245,8							
Weight of complete generator	kg		1118							
Maximun overspeed	rpm		2250							
Unbalanced magnetic pull at f.l.cl.F	kN/mm		5,9							
Cooling air requirement	m <sup>3</sup> /min		54				64,8			
Inertia Constant (H)	sec.		0,177				0,213			
Noise level at 1m/7m	dB(A)		94 / 82				98 / 88			

All technical data are to be considered as a reference and they can be modified without any notice.

This document is a propriety of Mecc Alte S.p.A.. All rights reserved.



**GENERATOR TYPE ECO 40-2S/4**

Document : **DS023A/2**  
 issue 008 date : 26/03/2013

**50 Hz**

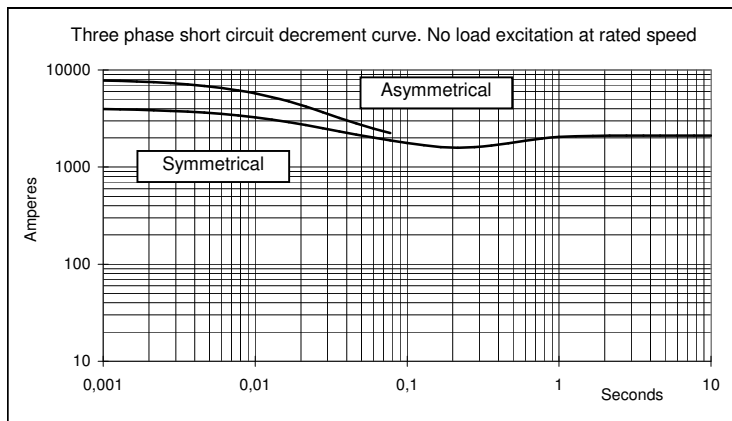
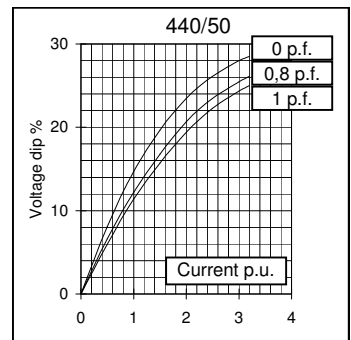
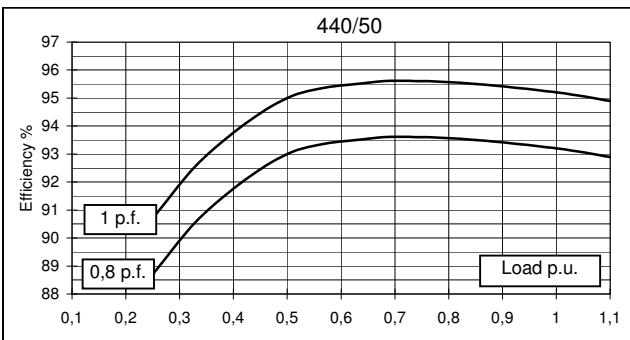
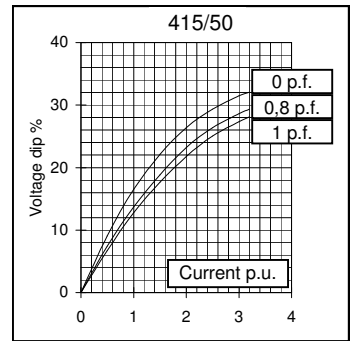
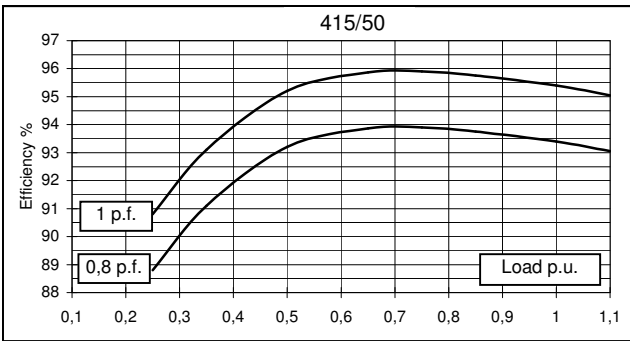
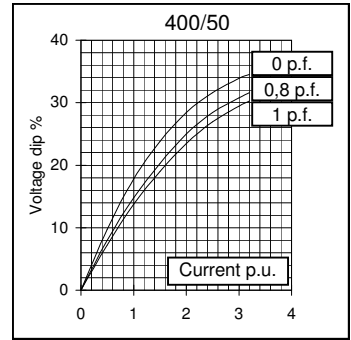
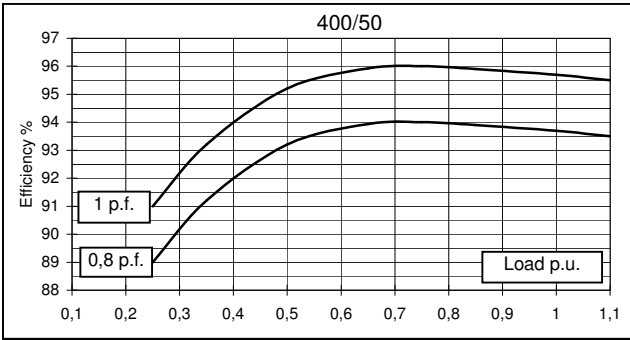
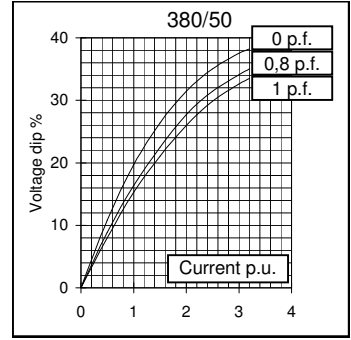
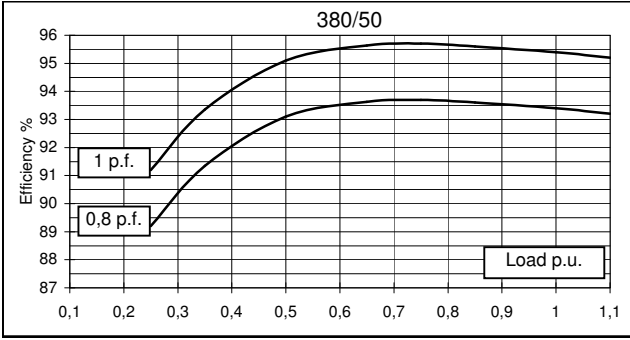

**60 Hz**

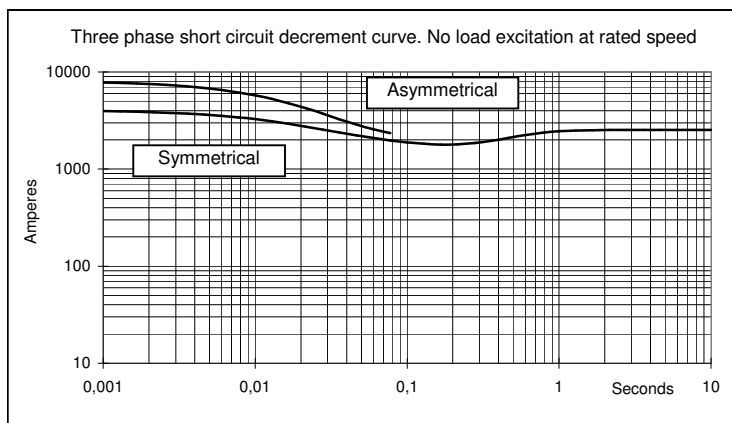
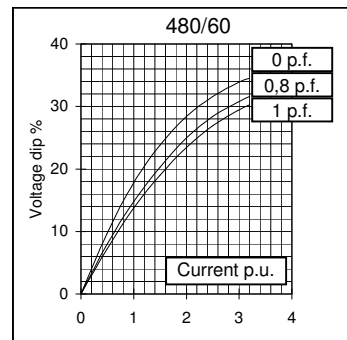
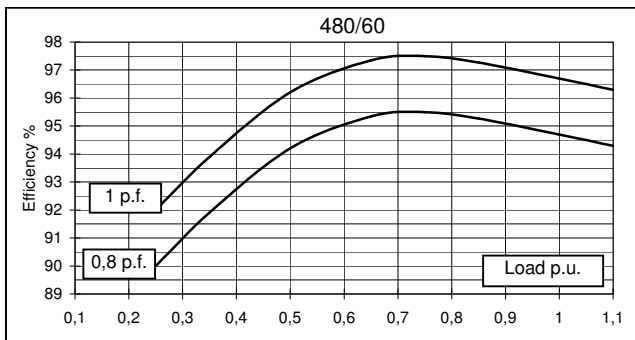
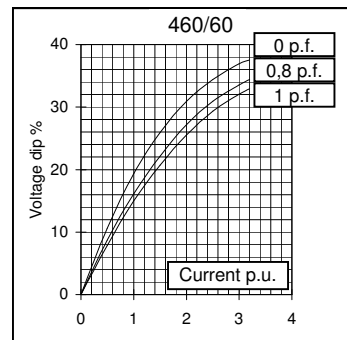
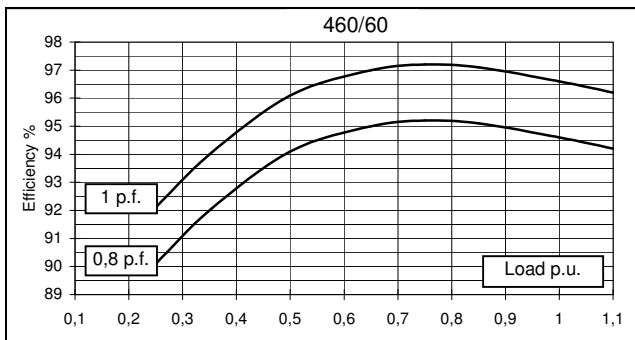
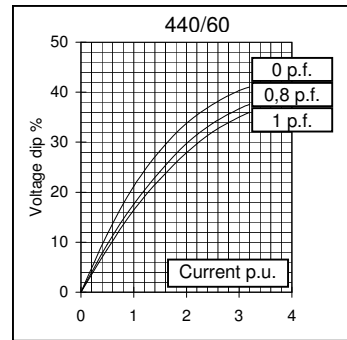
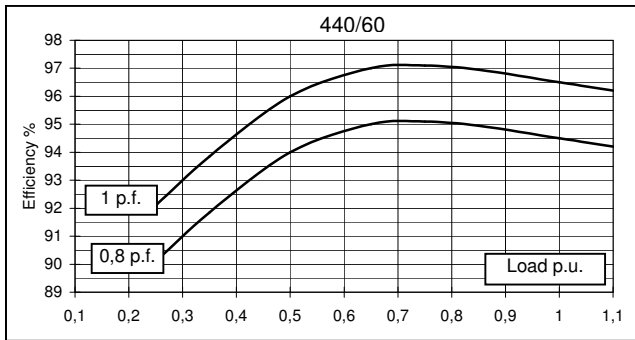
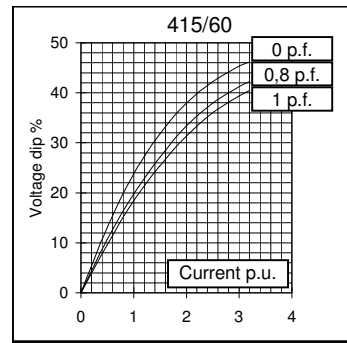
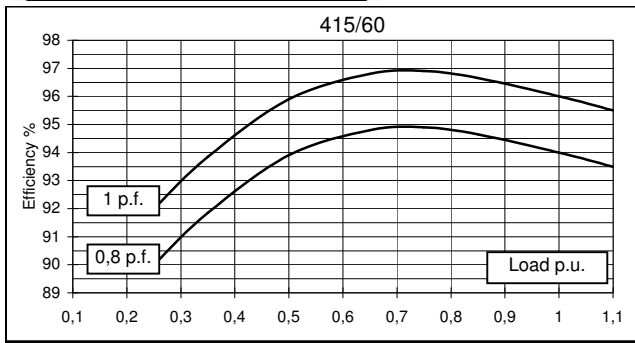

### TWO BEARING MOMENTS OF INERTIA

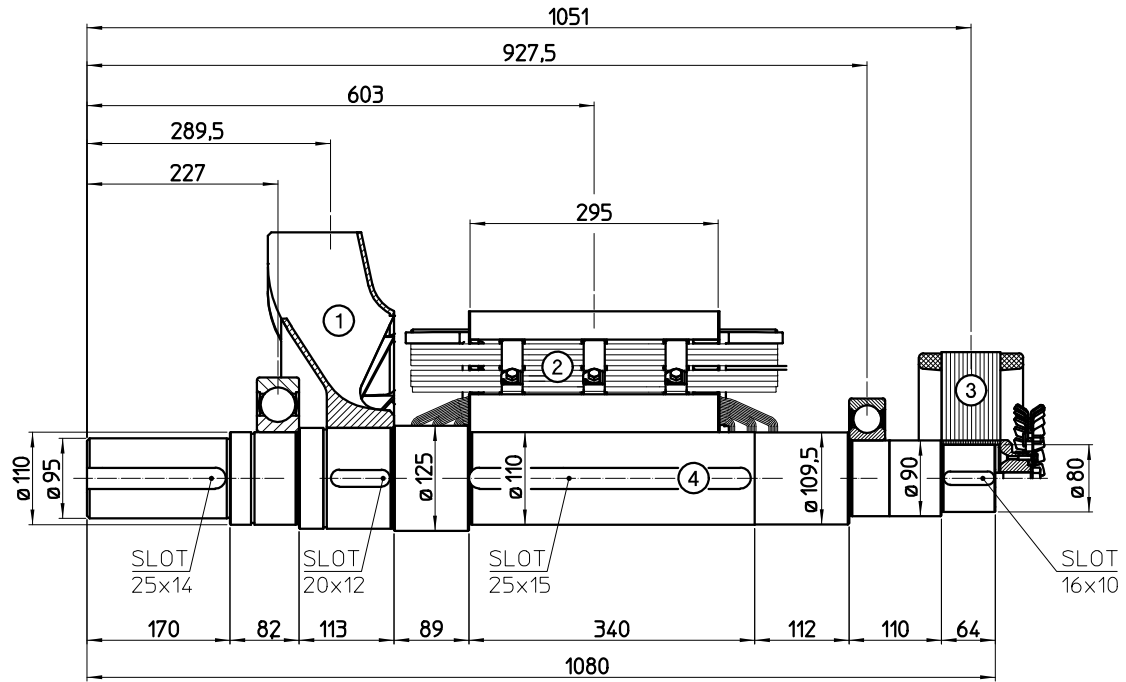

COMPONENT	WEIGHT kg	J kgm <sup>2</sup>
1 FAN	10,2	0,335
2 MAIN ROTOR	245,8	5,234
3 EX. ROTOR	35	0,562
4 SHAFT	73,6	0,109
TOTAL	364,6	6,24

### TWO BEARING DIMENSIONS

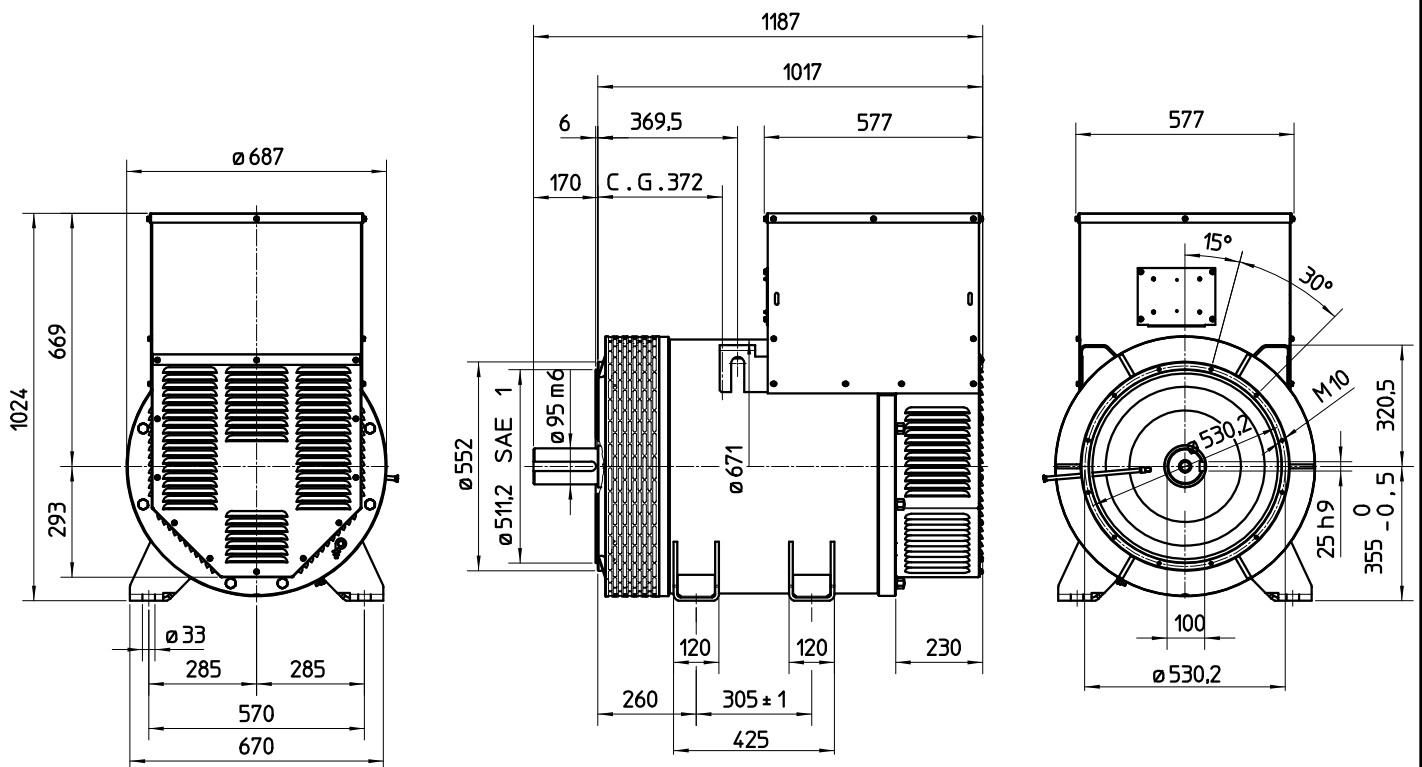

C.G.= GRAVITY CENTER

